



QUALITY | RELIABILITY | INNOVATION

Inverter Generator User manual

GS-6500IE



GENTRAX

Find your generator at gentrax.com.au

INTRODUCTION

Thank you for purchasing this Inverter Generator. Before attempting to use this product, please read this manual thoroughly and follow the instructions carefully. In doing so you will ensure the safety of yourself and that of others around you, and you can look forward to your purchase giving you long and satisfactory service.

CONTENTS

SAFETY INFORMATION.....	2
CONTROL FUNCTION	3
PRE-OPERATION CHECK	6
OPERATION.....	7
PERIODIC MAINTENANCE	11
TROUBLE SHOOTING	14
STORAGE	15
SPECIFICATION.....	16
WIRING DIAGRAM	17

! WARNING

PLEASE READ AND UNDERSTAND THIS MANUAL COMPLETELY BEFORE OPERATING THE MACHINE.

SAFETY INFORMATION

EXHAUST FUMES ARE POISONOUS

- Never operate the engine in a closed area or it may cause unconsciousness and death within a short time. Operate the engine in a well ventilated area.

FUEL IS HIGHLY FLAMMABLE AND POISONOUS

- Always turn off the engine when refueling
- Never refuel while smoking or in the vicinity of an open flame.
- Take care not to spill any fuel on the engine or muffler when refueling.
- If you swallow any fuel, inhale fuel vapor, or allow any to get in your eyes, see your doctor immediately. If any fuel spills on your skin or clothing, immediately wash with soap and water and change your clothes.
- When operating or transporting the machine, be sure it is kept upright. If it tilts, fuel may leak from the carburetor or fuel tank.

ENGINE AND MUFFLER MAY BE HOT

- Place the machine in a place where pedestrians or children are not likely to touch the machine.
- Avoid placing any flammable materials near the exhaust outlet during operation.
- Keep the machine at least 1 m (3 ft) from buildings or other equipment, or the engine may overheat.
- Avoid operating the engine with a dust cover.
- Be sure to carry the generator only by its carrying handle.
- Put the machine on the flat ground, for the machine eliminating heat freely.

ELECTRIC SHOCK PREVENTION

- Never operate the engine in rain or snow.
- Never touch the machine with wet hands or electrical shock will occur.
- Be sure to ground (earth) the generator.

NOTE:

Use ground (earth) lead of sufficient current capacity.

Diameter: 0.12mm (0.005 in)/ampere

EX: 10 Ampere –1.2mm (0.055 in)

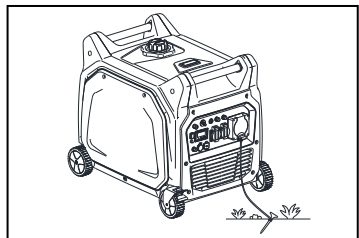

CONNECTION NOTES

- Avoid connecting the generator to commercial power outlet.
- Avoid connecting the generator in parallel with any other generator.

CONTROL FUNCTION

- | | | |
|------------------------------|-----------------------------|--------------------------------------|
| (1) Spark plug | (2) Fuel tank | (3) Fuel tank cap |
| (4) Fuel filter | (5) Carrying handle | (6) Fuel level gauge |
| (7) Muffler | (8) Battery | (9) Air filter |
| (10) Brake lever | (11) Wheel | (12) Oil filler cap |
| (13) Oil drain plug | (14) Choke rod | (15) Fuel cock |
| (16) Engine switch | (17) AC protector 15A | (18) Australia industrial socket 30A |
| (19) Ground (earth) terminal | (20) AC receptacle 15A | (21) USB Output |
| (22) DC 12V receptacle | (23) DC protector | (24) Data display instrument |
| (25) Output reset | (26) Economy control switch | (27) Remote control |

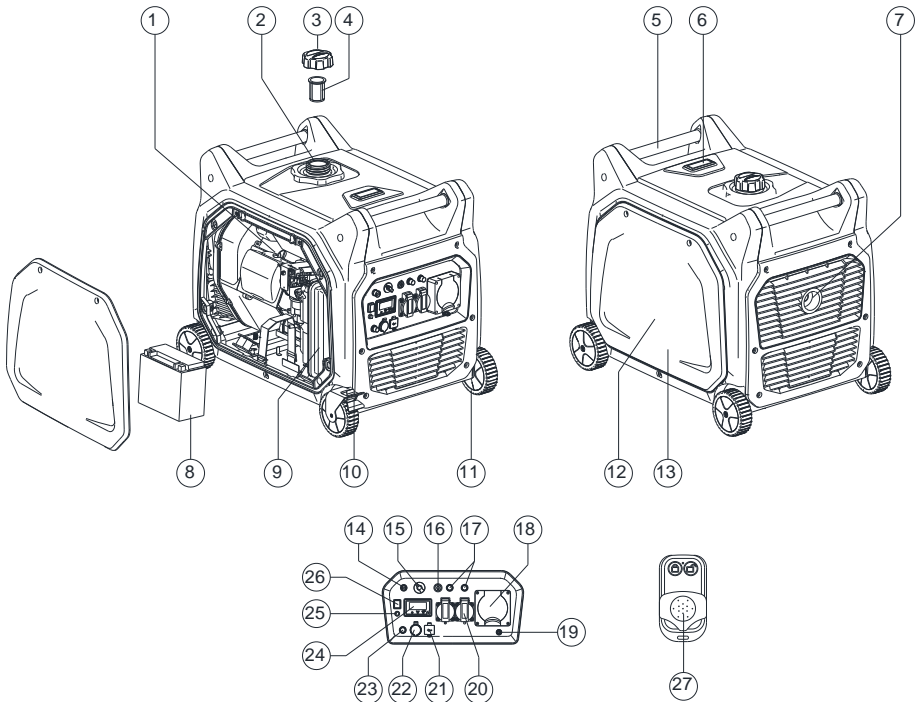

OIL WARNING SYSTEM

When the oil level falls below the lower level, the engine stops automatically. Unless you refill with oil, the engine will not start again.

ENGINE SWITCH

The engine switch controls the ignition system.

① RUN

Ignition circuit is switched on. The engine can be started.

② STOP

Ignition circuit is switched off. The engine will not run.

③ START

Starting circuit is switched on. The starter motor starts.

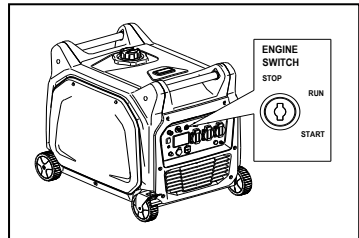
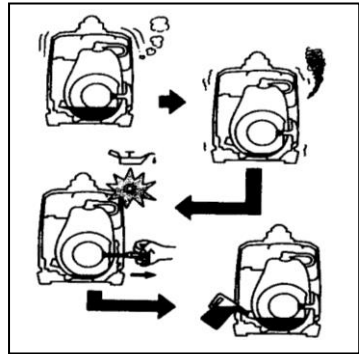

ECONOMY CONTROL SWITCH

When the economy control switch is turned **ON**, the economy control unit controls the engine speed according to the connected load. The results are better fuel connection and less noise.

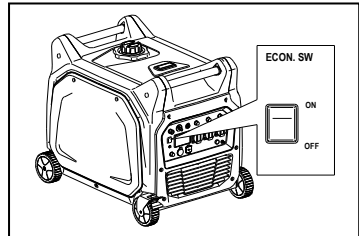

DC CIRCUIT PROTECTOR

The DC circuit protector turns off automatically when the load exceeds the generator rated output.

CAUTION:

- Reduce the load to within specified generator rated output if the DC circuit protector turns off.

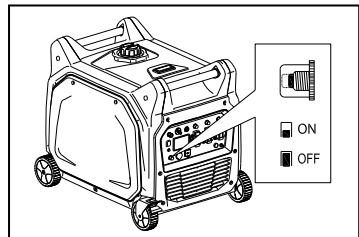

OUTPUT RESET

Push reset button for continuous 2 seconds, the generator will recover the AC output when the generator stops AC output under overload protection.

NOTE:

Please reduce the load of generator to ensure that the total load is within the rated power.

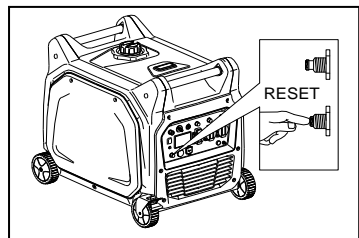

REMOTE CONTROL SWITCH

The remote control switch controls the ignition system



The starter motor starts.



The engine will not run.

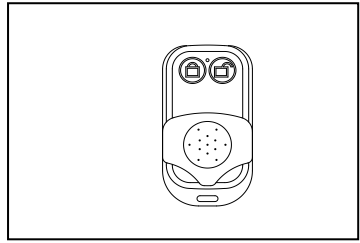

BRAKE LEVER

The function of brake lever is preventing generator moving.

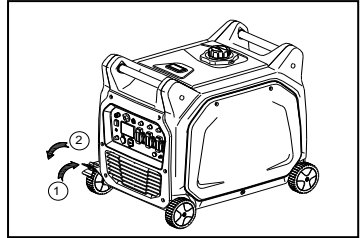

FUEL COCK

The fuel cock is used to supply fuel from the tank to the carburetor.

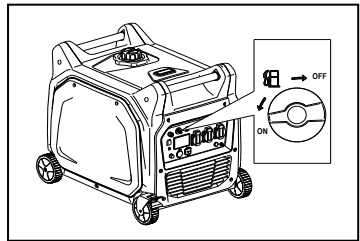

DATA DISPLAY INSTRUMENT



Normal



Short Circuit



Over Current



Maintenance



High Volt of AC output with E1AC indicated



High Volt DC mother line with E2DC indicated



Low Volt of AC output with E1AC indicated



Low Volt of DC mother line with E2DC indicated



MCU High Temperature with E3 indicated



IGBT High Temperature with E4 indicated



Low Oil with yellow light on

FAULT Defects or Overloads with red light on

OUTPUT Normal Running with green light on



Mode Selections: V1 → A1 → V2 → A2 → VA → Total Running Time → Current Running Time

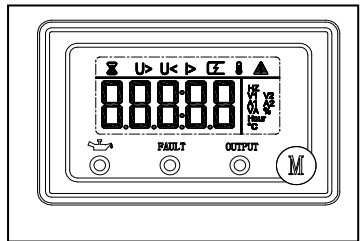

PRE-OPERATION CHECK

NOTE: _____

- Pre-operation checks should be made each time the generator is used.

CHECK ENGINE FUEL

- Make sure there is sufficient fuel in the tank.
- If fuel is low, refill with unleaded automotive gasoline.
- Be sure to use the fuel filter screen on the fuel filter neck.
- Recommended fuel: Unleaded gasoline.
- Fuel tank capacity: **18.5 L**.

WARNING: _____

- Do not refill tank while engine is running or hot.
- Close fuel cock before refueling with fuel.
- Be careful not to admit dust, dirt, water or other foreign objects into fuel.
- Do not fill above the top of the fuel filter or it may overflow when the fuel heats up later and expands.
- Wipe off spilt fuel thoroughly before starting engine.
- Keep open flames away.

CHECK ENGINE OIL

Make sure the engine oil is at the upper level of the oil filler hole. Add oil as necessary.

- Remove oil filler cap and check the engine oil level.
 - If oil level is below the lower level line, refill with suitable oil to upper level line. Do not screw in the oil filler cap when checking oil level.
 - Change oil if contaminated.
- Oil capacity: **1.1 L**
- Recommended engine oil:
API Service **SJ**

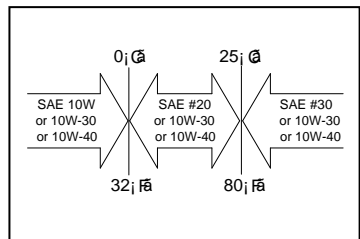
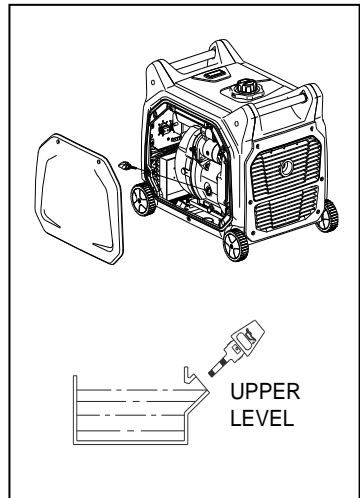
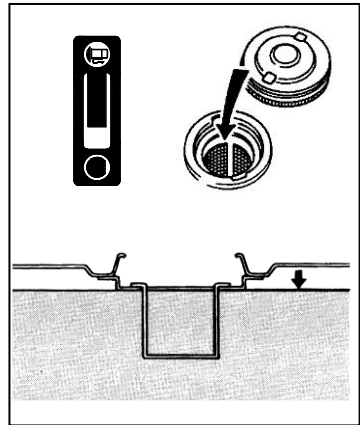

GROUND (Earth)

Make sure to ground (earth) the generator.

CONNECT BATTERY

- Loosen the screw and remove the battery cover.
- Clamp the **red** wire to the **positive (+)** terminal and the **black** wire to the **negative (-)** terminal of the battery. Do not reverse these positions.
- Be sure the battery is installed on the battery mount tray securely.
- Install the cover and tighten the screw.

NOTE: _____

- Recommended battery: 12V18AH.
-

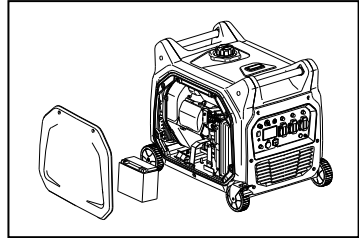
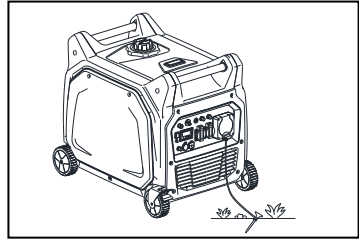

OPERATION

NOTE: _____

- The generator has been shipped without engine oil. Fill with oil or it will not start.
 - Do not tilt the generator when adding engine oil. This could result in overfilling and damage to the engine.
-

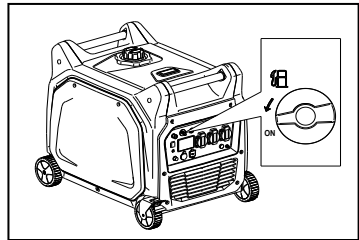

STARTING THE ENGINE

NOTE: _____

- Before starting the engine, do not connect the electric apparatus.
-

A Electric start

1. Turn the fuel cock lever to the **ON** position.
2. Pull out choke rod to the **CHOKE** position.
3. Turn the engine switch to the **START** position.

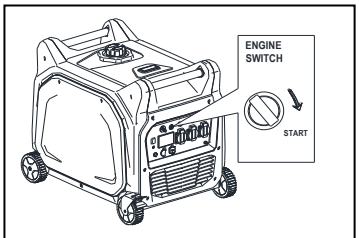
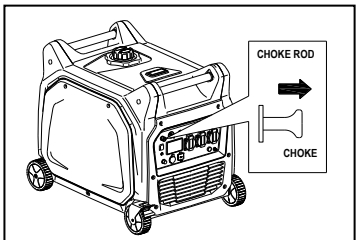

4. Turn the engine switch to the **RUN** position.
5. Push choke rod to the **RUN** position.
6. Warm up the engine without a load for a few minutes.

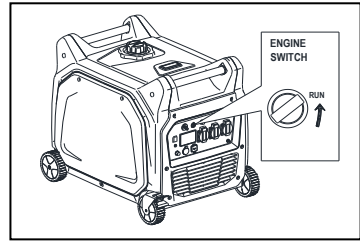

B Remote start

1. Please make sure the fuel shutoff valve to the **ON** position, the choke rod to the **RUN** position, the engine switch to the **RUN** position.
2. Press the  button on the remote control (key fob) **twice**.
3. Please wait **10 seconds** and repeat again if it couldn't start.
4. Warm up the engine without a load for a few minutes.

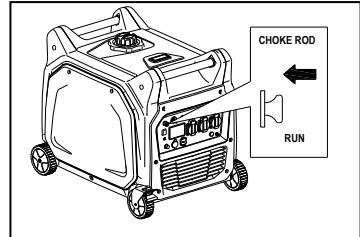

CAUTION:

- Make sure there are enough fuel inside the generator tank.
- Make sure generator battery fully be charged and at least charged each two months

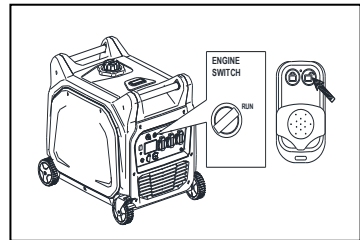

USING ELECTRIC POWER

1. AC APPLICATION

- (a) Check the AC pilot lamp for proper voltage.
- (b) Turn off the switch(es) of the electrical appliance(s) before connecting to the generator.
- (c) Insert the plug(s) of the electrical appliance(s) into the receptacle.

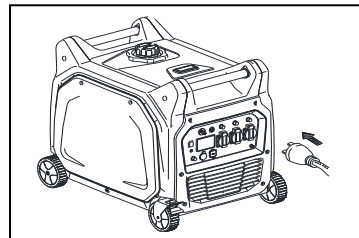

CAUTION:

- Be sure the electric apparatus is turned off before plugging in.
- Be sure the total load is within generator rated output.
- Be sure the socket load current is within socket rated current.
- The economy control switch must be turned to **OFF** when using electric devices that require a large starting current, such as a compressor or a submersible pump.

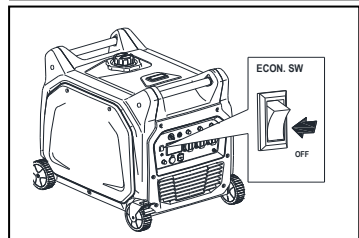

2. OVERLOAD INDICATOR LIGHT

The overload indicator light flickers when an overload of a connected electrical device is detected. This situation shall not be kept for a long time and it just needs to decrease the loads to its normal range and the overload indicator light will go off.

When the load is detected to exceed the maximum power or the AC output voltage is reduced, the overload indicator light will come on and the electronic breaker will then activate, stopping power to the generation in order to protect the generator and any connected electric devices. The output pilot light (Green) will be off, the overload indicator light will turn RED. It is needed to process as follows,

- (a) Turn off any connected electric devices
- (b) Reduce the total wattage of connected electric.
- (c) Check for blockages in the cooling air inlet, muffler air exhaust pipe opening and the control unit.
- (d) After inspection, press the reset button to restore the power supply of the generator.

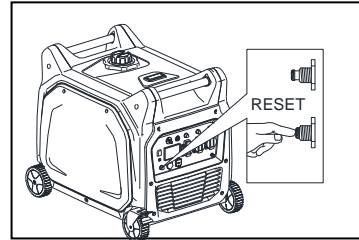
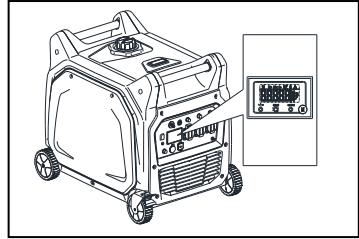

CAUTION:

- The generator AC output automatically resets when the engine is stopped and then restarted.
- The overload indicator light may come on for a few seconds at first when using electric devices that require a large starting current, such as a compressor or a submersible pump. However, this is not a malfunction.

3. DC APPLICATION (option)

This usage is applicable to 12V battery charging only.

- (a) Charging instruction for battery
 - Disconnect the leads for the battery.
 - Make the battery fluid filler cap loose fully.
 - Fill distilled water to the upper limit, if the battery fluid is low level.
 - Measure the specific gravity for the battery fluid by using the hydrometer, and calculate the charging time in according with the table shown on right side.
 - The specific gravity for the fully charged battery shall be within 1.26 to 1.28. It is recommended to confirm every an hour.

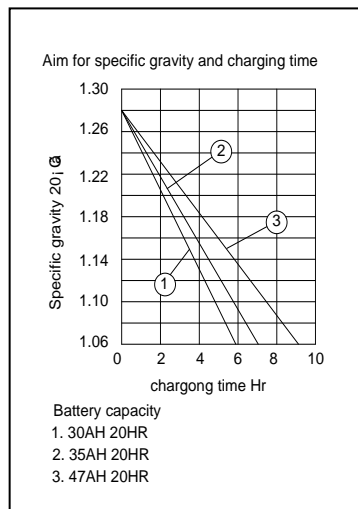

- (b) Connect between the DC output socket and the battery terminals using the charging leads. The leads shall be connected making sure of the (+) and (-) polarity.
- (c) The DC circuit protector is to be set to **ON** after confirming the connection, if the protector is in **OFF** position.

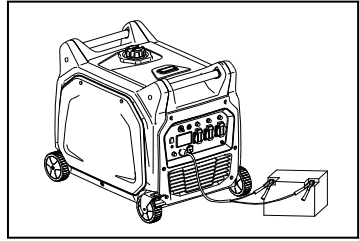

CAUTION: _____

- Be sure the economy control switch is turned off while charging the battery.

STOPPING THE ENGINE

1. Turn off the power switch of the electric apparatus or disconnect any electric devices.
2. Turn the engine switch to **STOP** position.
Click remote switch to the  position.
3. Turn the fuel cock lever to **OFF**.

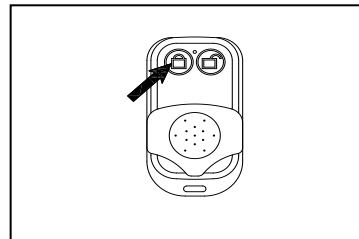
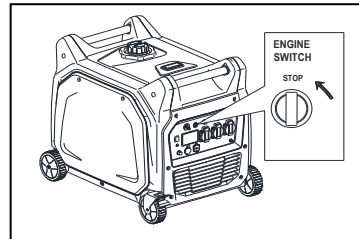

CAUTION: _____

- Place the engine switch in the **STOP** position if the generator set is not used for a long time.
If it is placed in the **RUN** position, the remote control module is in the state of receiving signal, which will consume the battery power, and the battery needs to be charged regularly.

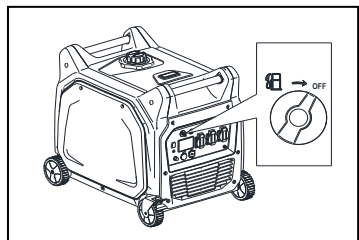

PERIODIC MAINTENANCE

MAINTENANCE CHART

Item	Remarks	Pre-operation check (daily)	Initial 1 months or 20 Hr	Every 3 months or 50Hr	Every 6 months or 100Hr	Every 12 months or 300Hr
Spark Plug	Check condition adjust gap and clean. Replace if necessary.			●		
Engine Oil	Check oil level	●				
	Replace		●		●	
Air Filter	Clean. Replace if necessary.			●		
Fuel Filter	Clean fuel cock filter. Replace if necessary				●	
Choke	Check choke operation	●				
Valve Clearance	Check and adjust when engine is cold.					●
Fuel Line	Check fuel hose for crack or damage. Replace if necessary.	●				
Exhaust System	Check for leakage. Retighten or replace gasket if necessary	●				
	Check muffler screen. Clean / replace if necessary.					●
Carburetor	Check choke operation	●				
Cooling system	Check fan damage.					●
Starting system	Check recoil starter operation.	●				
Idle speed	Check and adjust engine idle speed					●
Fittings / Fasteners	Check all fittings and fasteners correct if necessary.				●	
Crankcase breather	Check breather hose for cracks or damage. Replace if necessary					●
Generator	Check the pilot light comes on	●				

Regular maintenance is most important for the best performance and safe operation.

ENGINE OIL REPLACEMENT

1. Place the machine on a level surface and warm up the engine for several minutes. Then stop the engine and turn the fuel cock knob to **OFF**. Turn the fuel tank cap air vent knob clockwise.
 2. Loosen the screw and remove the cover.
 3. Remove the oil filler cap
 4. Place an oil pan under the engine. Tilt the generator to drain the oil completely
 5. Replace the generator on a level surface.
 6. Add engine oil to the upper level.
 7. Install the oil filler cap
 8. Install the cover and tighten the screw
- Recommended engine oil: **1.1 L.**

API Service **SJ**

CAUTION:

- Be sure no foreign material enters the crankcase.
- Do not tilt the generator when adding engine oil. This could result in overfilling and damage to the engine
- Clean the oil filter every other 100hr.

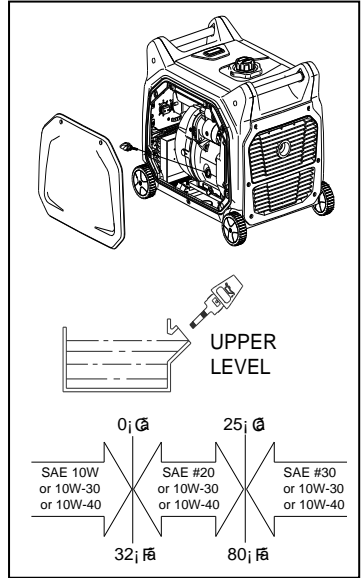
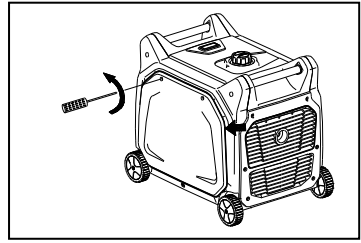

AIR FILTER

Maintaining an air cleaner in proper condition is very important. Dirt induced through improperly installed, improperly serviced, or inadequate elements damages and wears out engines. Keep the element always clean.

1. Remove the cover.
2. Remove the air filter cover and element.
3. Wash the element in solvent and dry.
4. Oil the element and squeeze out excess oil. The element should be wet but not dripping.
5. Insert the element into the air filter.
6. Install the cover

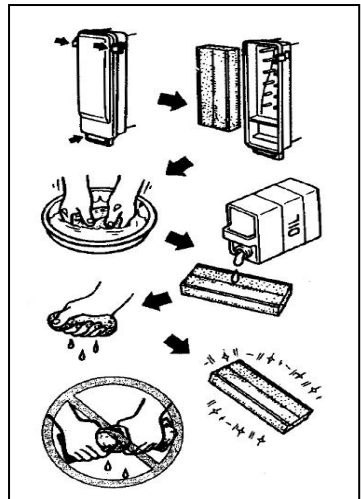

CAUTION: _____

The engine should never run without the element; excessive piston and/or cylinder wear may result.

CLEANING AND ADJUSTING SPARK PLUG

1. Remove the cover.
2. Check for discoloration and remove the carbon.
3. Check the spark plug type and gap.
4. Install the spark plug.
5. Install the cover

Standard electrode color: Tan Color
Standard Spark Plug: F6RTC (TOUCH)
Spark Plug Gap: 0.6-0.7 mm (0.024-0.028 in)

FUEL TANK FILTER

1. Remove the fuel tank cap and filter.
2. Clean the filter with solvent. If damaged, replace.
3. Wipe the filter and insert it.

! WARNING _____

- Be sure the tank cap is tightened securely.
-

MUFFLER SCREEN

! WARNING _____

- The engine and muffler will be very hot after the engine has been run.
 - Avoid touching the engine and muffler while they are still hot with any part of your body or clothing during inspection or repair.
-

1. Remove the cover.
2. Remove the muffler screen.

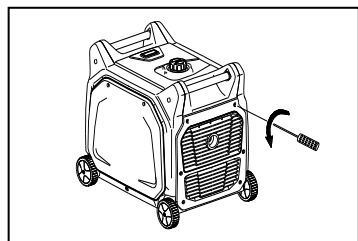
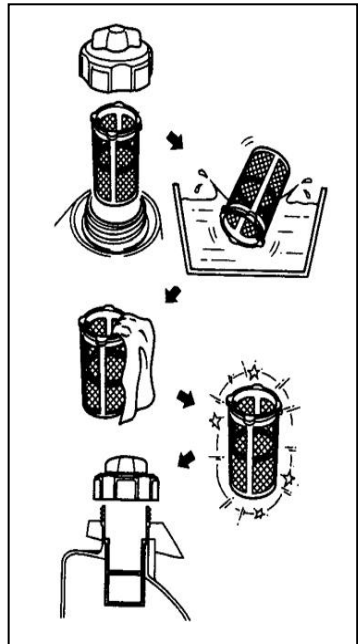
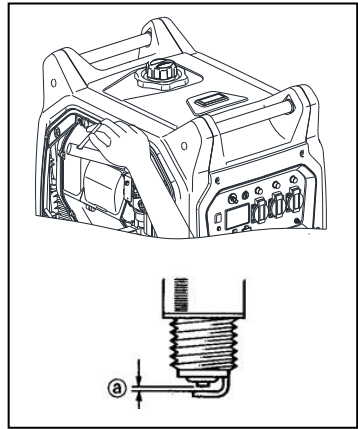

3. Use the flathead screw driver to pry the spark arrester out from the muffler
4. Remove the carbon deposits on the muffler screen and spark arrester using a wire brush.
5. Install the muffler screen.
6. Install the cover

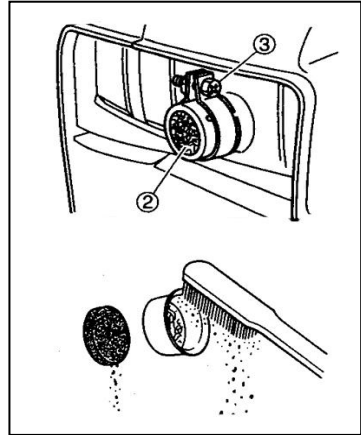

TROUBLE SHOOTING

Engine won't start

1. Fuel systems

No fuel supplied to combustion chamber.

- No fuel in tank....Supply fuel.
- Fuel in tank....Fuel tank cap air vent knob to **ON**, fuel cock knob to **ON**.
- Clogged fuel line....Clean fuel line.
- clogged carburetor....Clean carburetor.

2. Engine oil system

Insufficient

- Oil level is low....Add engine oil.

3. Electrical systems

Poor spark

- Spark plug dirty with carbon or wet...Remove carbon or wipe spark plug dry.
- Faulty ignition system....Consult dealer.

4. Compression insufficient

- Worn out piston and cylinder....Consult dealer.

Generator won't produce power

Safety device (AC) to **OFF** ...Stop the engine, then restart.

Safety device (DC) to **OFF** ...Press to reset the DC protector

STORAGE

Long term storage of your machine will require some preventive procedures to guard against deterioration.

DRAIN THE FUEL

1. Remove the fuel tank cap, drain the fuel from the fuel tank
2. Remove the cover, drain fuel from the carburetor by loosening the drain screw.

ENGINE

1. Remove the spark plug, pour in about one tablespoon of SAE 10W30 or 20W40 motor oil into the spark plug hole and reinstall the spark plug.
2. Use the recoil starter to turn the engine over several times (with ignition off).
3. pull the recoil starter until you feel compression.
4. Stop pulling.
5. Clean exterior of the generator and apply a rust inhibitor.
6. Store the generator in a dry, well-ventilated place, with the cover place over it.
7. The generator must remain in a vertical position.

SPECIFICATION

MODEL		XYG6500IE
GENERATOR	Type	Inverter Generator
	AC Voltage	240V
		50Hz
	Max. Output	6.6 kW
	Rated Output	6.0 kW
	Power Factor	1.0
	DC Output	12V / 5.0A 5V/3.1A
ENGINE	Model	XY188F-1
	Type	Air-cooled, 4 cycle, OHV, Gasoline Engine
	Bore × Stroke mm × mm	88 × 64
	Displacement	389cc
	Max. Output	7.5kW / 3600rpm
	Fuel	Regular Automobile Gasoline
	Fuel tank Capacity	18.5 liters
	Rated Continuous Operation	4h30min (100% Load)
	Lubricating oil	SAE 10W30
	Lubricating oil Capacity	1.1 liter
	Starting System	Electric Starter / Remote starter
	Ignition system	C.D.I.
	Spark Plug: Type	F6RTC
DIMENSION	Net dimension L × W × H	750 × 537 × 630
	Overall dimension L × W × H	800 × 590 × 670
	Net Weight	89 kg
	Dry Weight	101 kg

- Specifications subject to change without prior notice.

WIRING DIAGRAM

240V

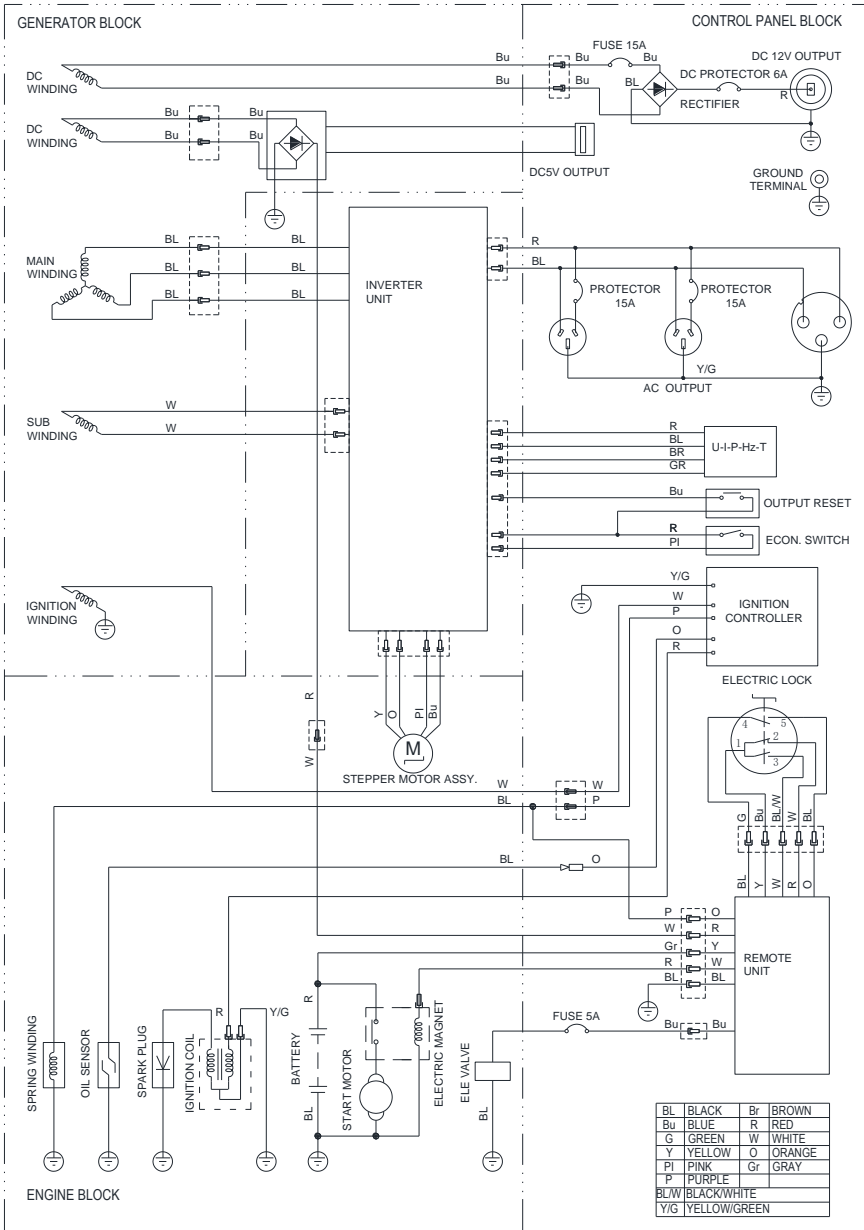

GENTRAX

Find your generator at [gentrax.com.au](https://www.gentrax.com.au)

QUALITY | RELIABILITY | INNOVATION

